

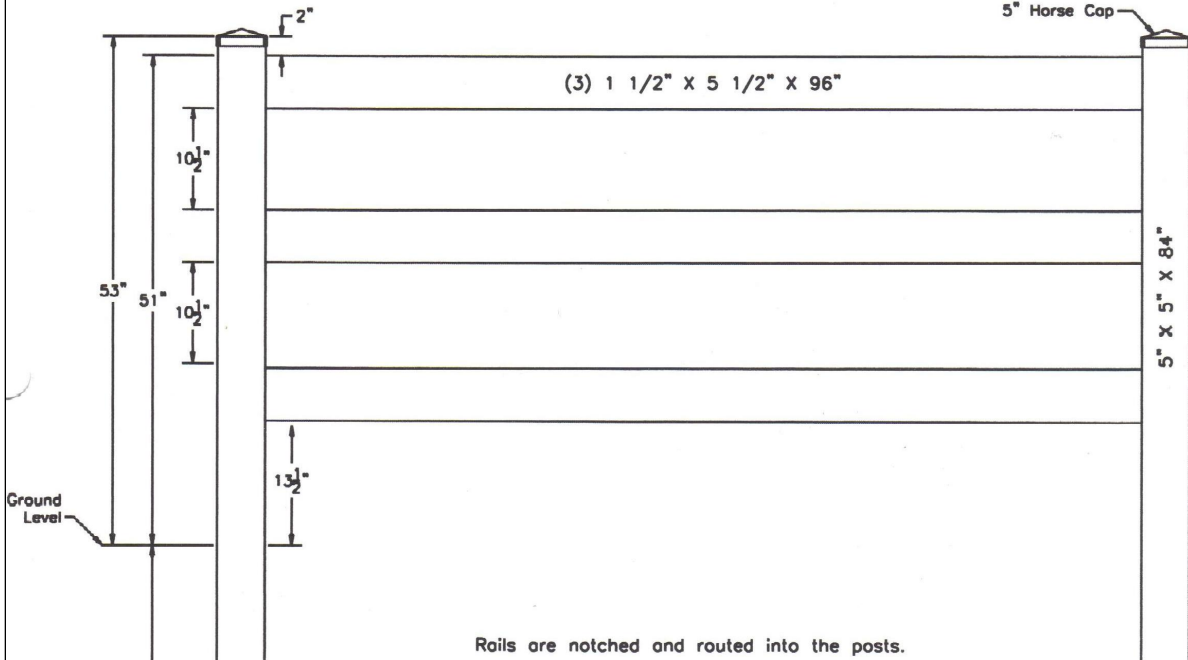

Vinyl Fence Installation Instructions

Rail Fence Fence Installation Instructions





Ranch Rail Vinyl Fence Installation Instructions

Tips Before You Start

- Read this instruction sheet completely.
- During fence assembly, work on a soft, non-abrasive surfaces where possible to avoid scratching the PVC.
- When cutting PVC components with a power saw, use a fine-toothed blade (plywood blade, finishing blade, or a metal blade).
- Laying out the fence is the critical first step toward ensuring a quality installation.

Fence components

(8' wide section)

- A.** 5x5 Vinyl Posts (1)
- B.** 1-1/2" x 5-1/2" Pocket Rail (3)
- C.** 5x5 Post Cap (1) (different style than shown)
- E.** 1-7/8" O.D. X 8' Long H.D. Galvanized Pipe (1)
- F.** 1-7/8" Adjustable Post Collars (2)

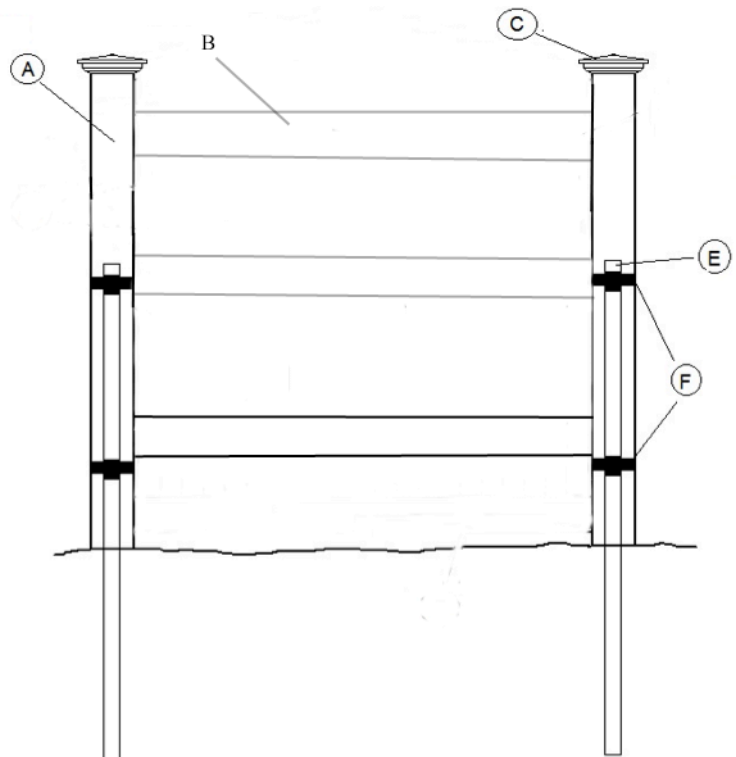



Ranch Rail Vinyl Fence Installation Instructions

Step 1 Setting Fence Layout

- **It is important to have the utilities checked to avoid puncturing any unseen lines.**
- **It is also important to check property lines before laying out your fence line.**
- Ensure the fence is within your property to avoid encroaching adjacent property. Get a survey done if needed to determine where the line actually is.
- Steel posts should be spaced 96" on center or 94" inside to inside (**one of the vinyl rails can be used as a spacer**). For 6' sections posts should be 72" on center.
- Dig your holes 2' -3' deep, and about 8" x 8" with the post centered. Pour concrete and set posts.
- Use a level and your string line to ensure that the steel posts are as plumb as possible. Post collars will allow for adjustment after.

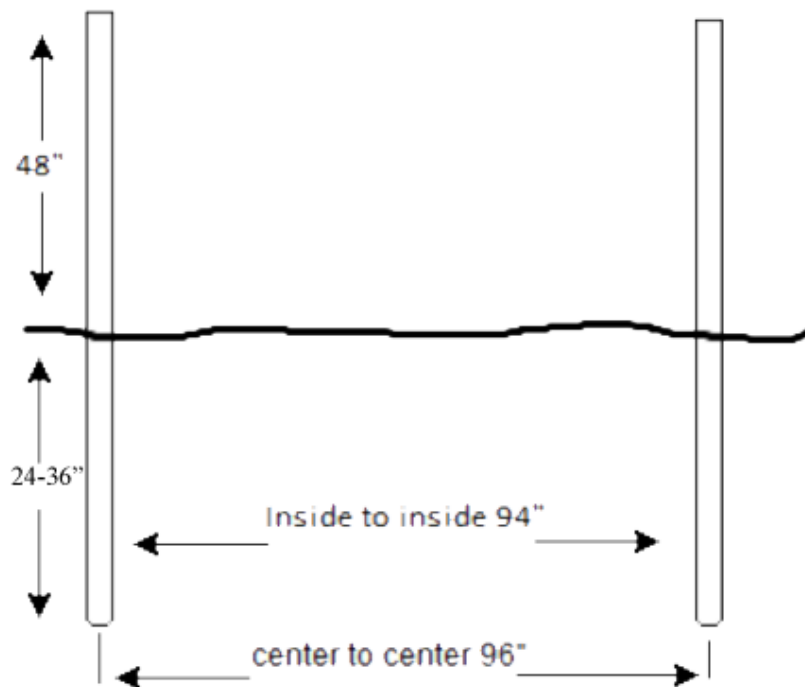



Ranch Rail Vinyl Fence Installation Instructions

Step 2 Setting Post Collars

- Each post gets two sockets which consist of an inner ring and an outer ring.
- Slip inner rings cogs facing up and outer rings cogs facing down onto posts in alternating order starting with a small ring.

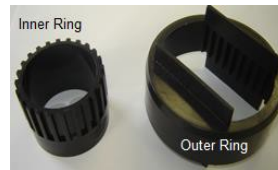

Note: The bottom collar should be set below ground level by digging at base of post (Fig B.) This will affect how you set your fence for height in Step 3.

- Ensure the top collar does not interfere with rails
- Next, fasten the smaller rings in position with self-tapping screws then using a level set the large rings of all the end and corner posts making sure they are plumb in both directions.
- It is best to set all bottom sockets in a parallel direction along the fence line and top sockets in a perpendicular direction away from the fence line.

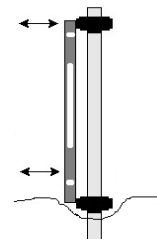

Figure B



Ranch Rail Vinyl Fence Installation Instructions

Step 3 String Line

- Once the corner and end post collars are set run the string-line on the top collars for each run of fence from end posts to corner posts etc. (Figure A)
- Adjust remaining collars to string and fasten to posts.
- Using the level, plumb the remaining bottom collars with the top collars and fasten to the posts.

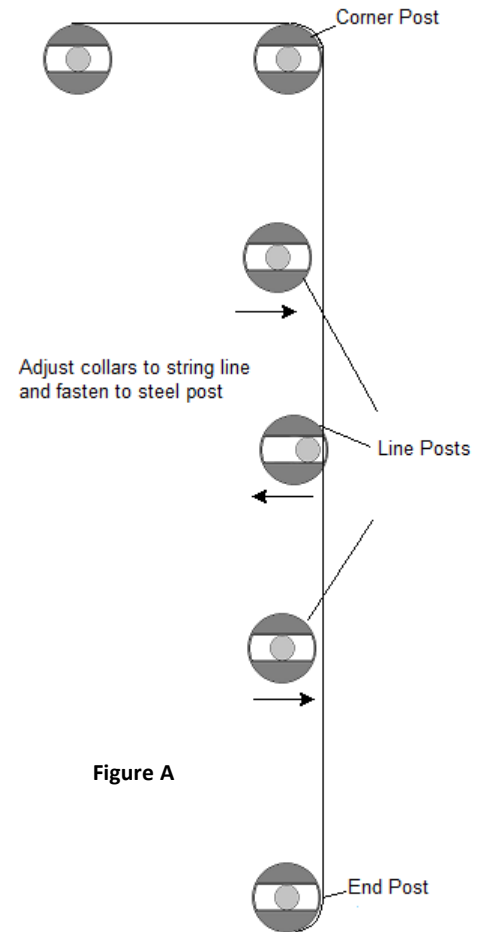

Figure A

Step 4 Setting posts for height

- Place all 5x5 vinyl posts over the steel posts & sockets (long end down) making sure they are in the correct positions, ie: line, corner, end etc.

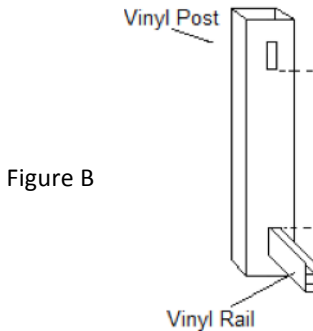

Figure B



Ranch Rail Vinyl Fence Installation Instructions

- Set end posts and corner posts for height by inserting a screw (or two) into the lower socket through the vinyl post. (Figure E)
- Run a string over the top of posts from end to end of each fence line. Then set the rest of the posts to height by lifting to string and fastening to bottom collars, Figure F.

Figure E

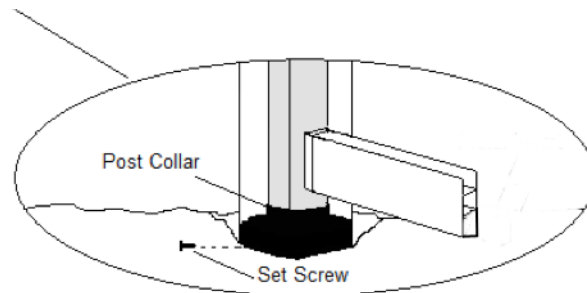
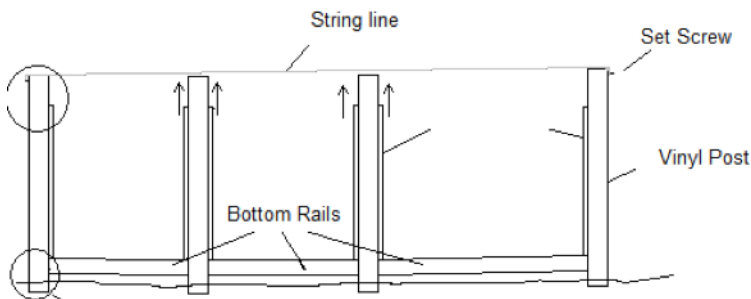

Figure F





Ranch Rail Vinyl Fence Installation Instructions

Step 5 – Install Rails

- Attach brackets to existing posts
 - be sure they line up with holes on vinyl.
- To get correct rail length, butt against steel post. Measure to the outside of the following posts and add 3/8" . Cut to length.
-

Top View

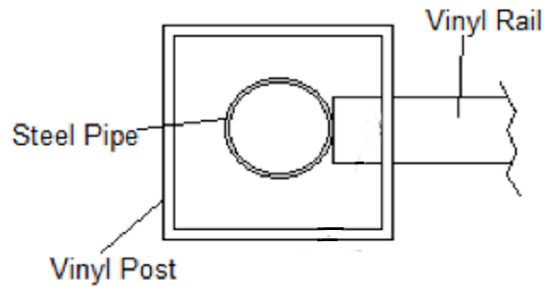

Top View

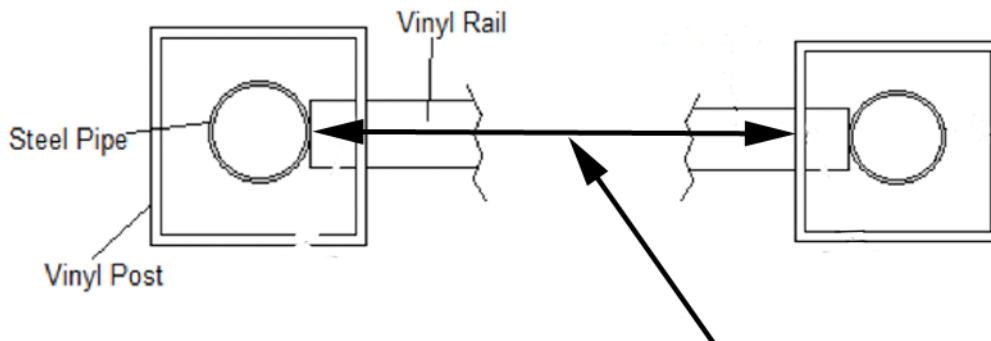

- Insert and slide back and forth to ensure length is right and rail does not slide out.

Tip: to install rail, slide one end and then twist and turn the next post – do this BEFORE you screw post into collar.

- Glue on Caps

Step 6 - Sit on your lawn Chair and enjoy your Maintenance Free Vinyl Fence